

5597
258
214

Bild 47



Bild 47. Stromlauf des ZF-Teiles I

Rö 31,35,36,38
EF 800



Rö 32,33,34
EF 805 S

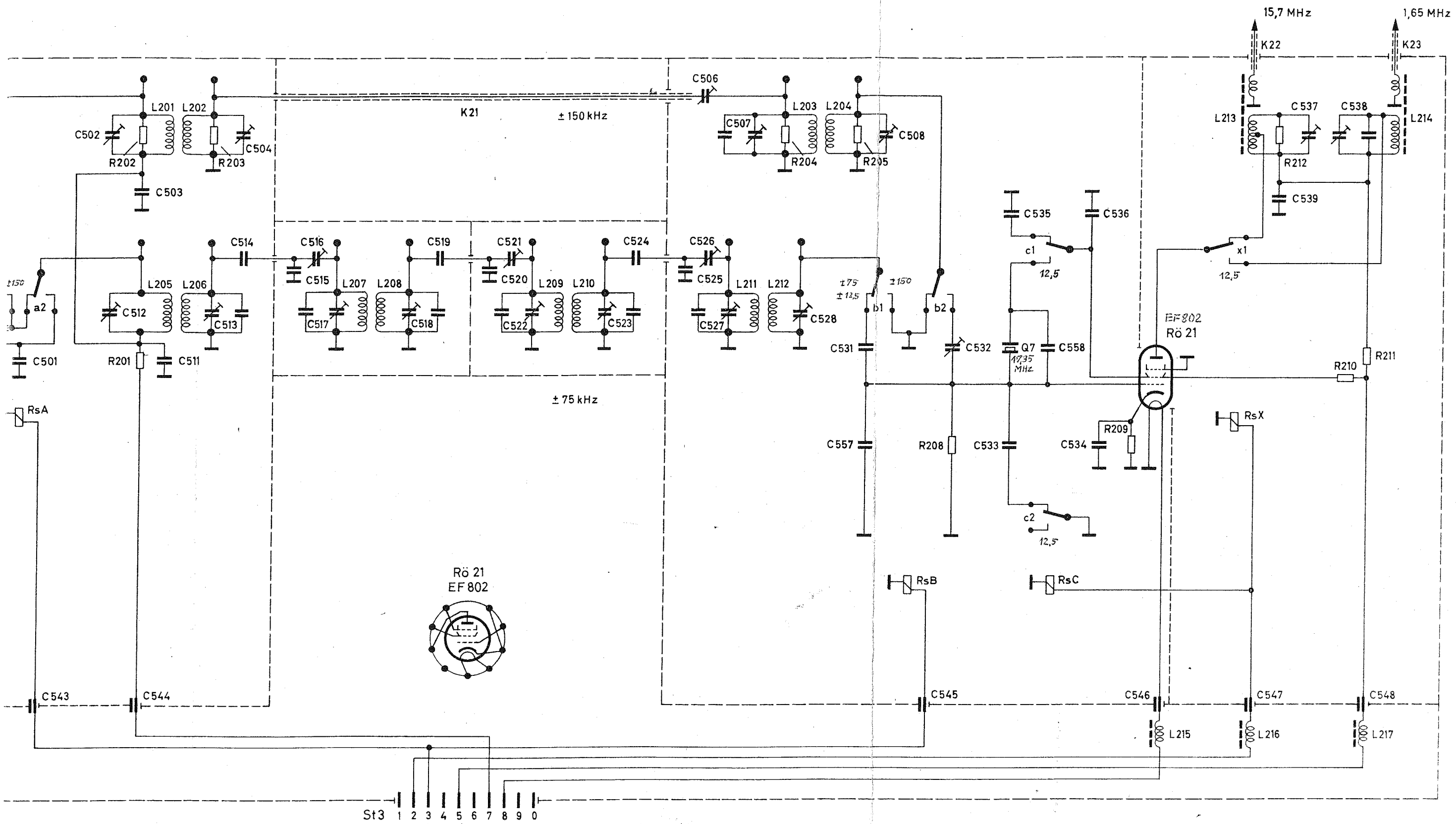
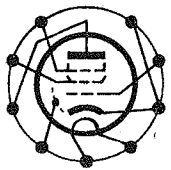

Rö 37,40
E 180 F

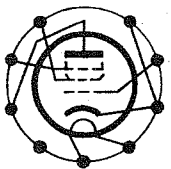

Rö 39
EL 803

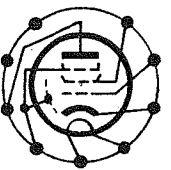

Rö 41,42
EAA 91

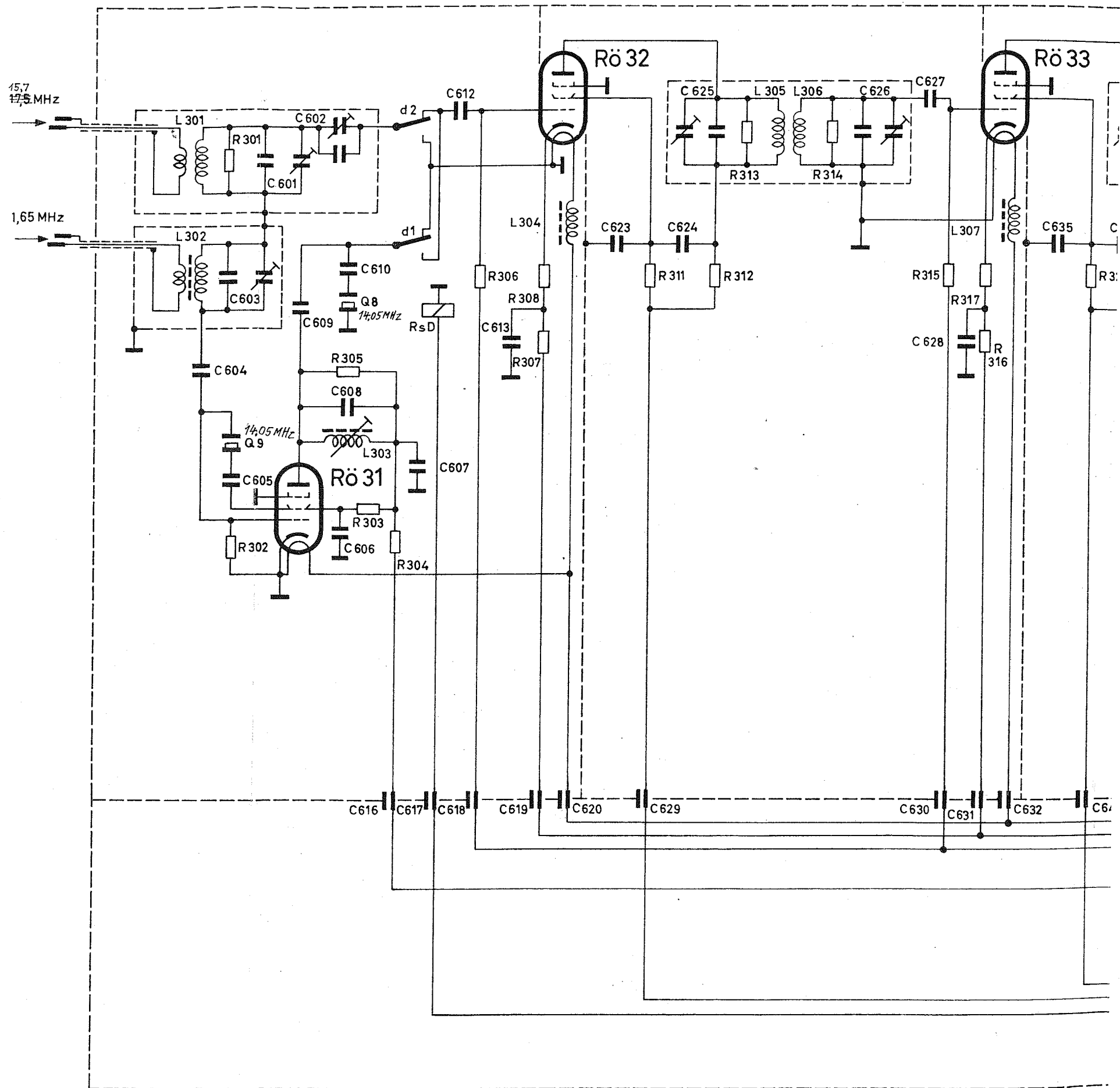
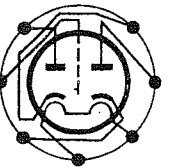

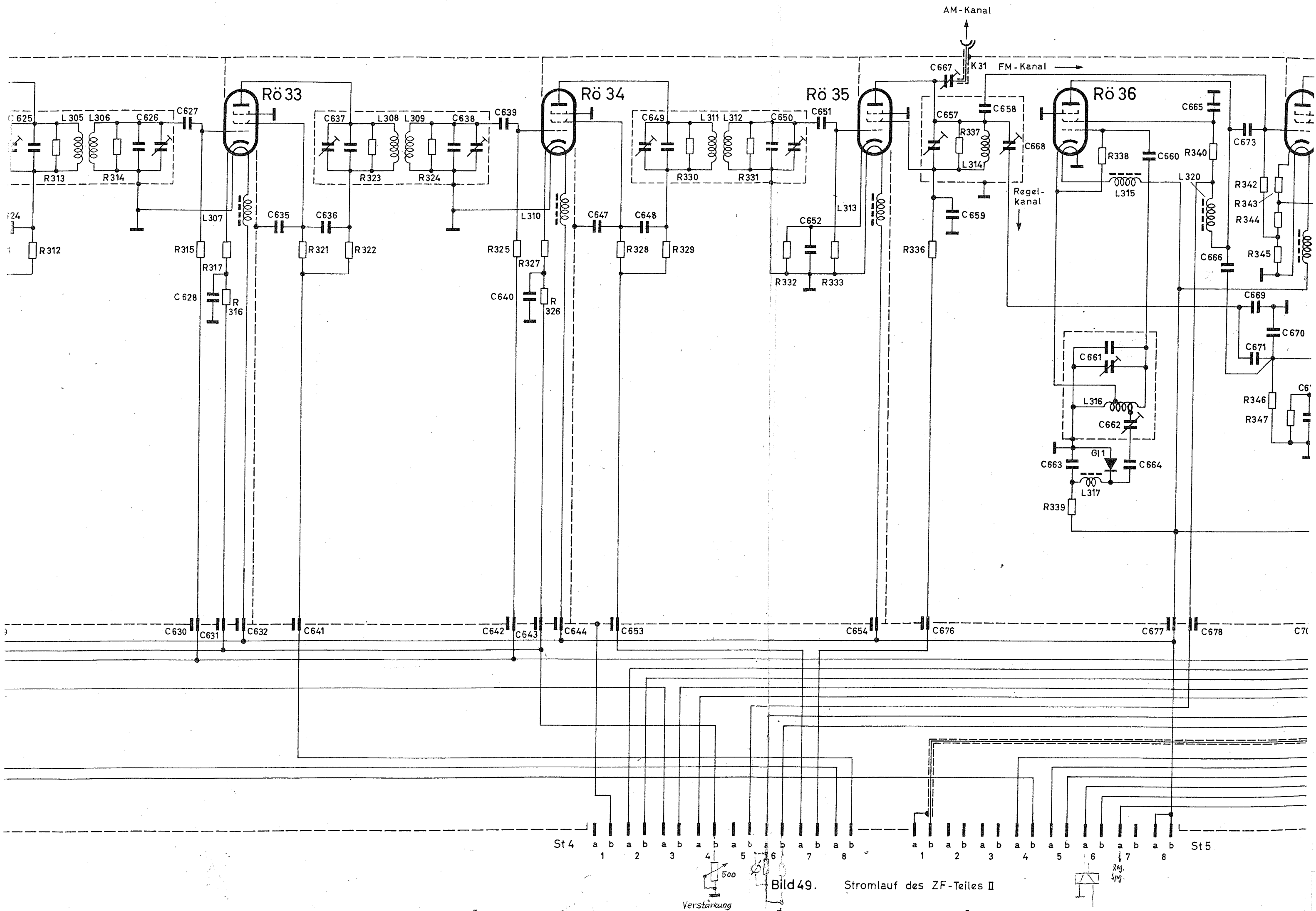

Bild 49. Stromlauf des ZF-Teiles II

